

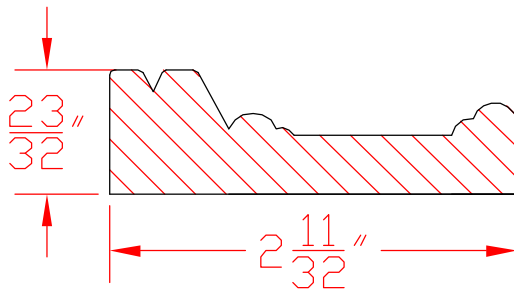

2-48

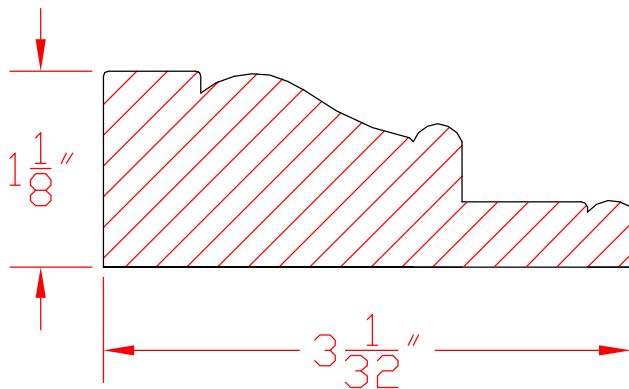

2-22



bin 283

 <b>Accent Architectural Millworks, Inc.</b>	
Mouldings	
ITEM	Casings
PROJECT	Page #
SCALE Full	DATE: 01/01/02
8-31	